

Product Overview

Catco catalytic heaters bring fuel and oxygen together in the presence of a heated catalyst. This causes a chemical reaction that produces infrared heat but no flame, and the catalyst is not consumed by the reaction. Once it's operational, a catalytic heater can operate indefinitely if it has a clean source of fuel and sufficient air.

The 24x72 heater is most commonly used in space heating applications in remote and/or hazardous locations.

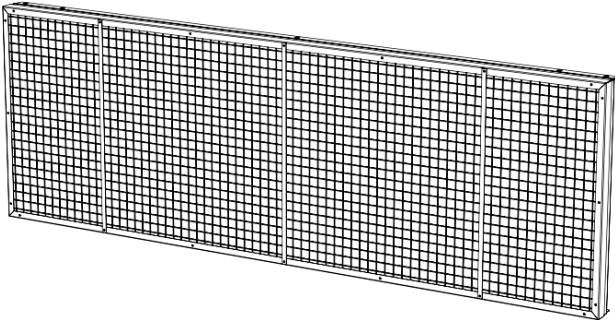



Product Specs

Fuel

Rating BTU/hr (kW)	Fuel Consumption	
	Natural Gas SCFH (m3/hr)	Propane lb/hr (kg/hr)
72,000 (21.10)	72.0 (2.04)	3.33 (1.51)

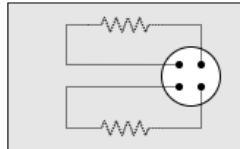
Electrical

Heating Elements	Bus Bar Arrangement
	Parallel Heating Elements (12 V, 120 V) 
	Series Heating Elements (24 V, 240 V, 480 V) 

Starting Amperage, A				
12 V	24 V	120 V	240 V	480 V
33.3	16.7	8.3	4.2	2.1

Part Number Key

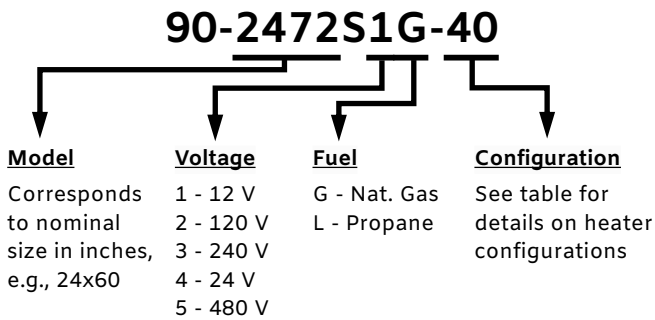

Accessories

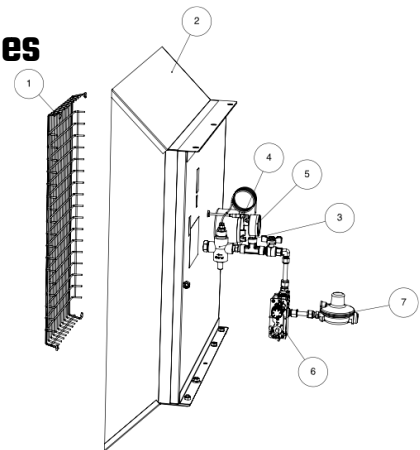

Heater Configurations

Config	Hazardous Location Listing		Junction Box		Valve and Thermo-couple
	Class I Div 1 Group D	Class I Div 2 Group D	Plain	EP	
-10			•		
-20				•	
-30		FM	•		•
-40	FM	FM		•	•
-50	CSA	CSA		•	•

	Part Number	Description
1	60-011	Facegrill (requires qty 4)
2	61-031	Reflector
3	30-127	Shutoff valve (aka safety valve)
4	30-010	Thermocouple
5	35-076	Water column pressure gauge
6	40-037-G60000	Thermostat (natural gas)
7	50-005	912 style low pressure regulator
	10-027	Wall-mount brackets (not shown)
	10-072	Floor stand (not shown)

For additional accessories and more information, see the *Catalytic Heater Product Bulletin*.